

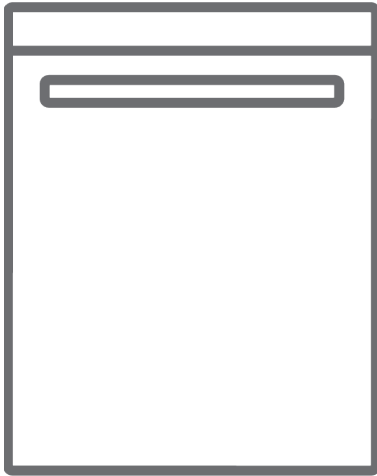

**USA/CAN Dishwasher / User Manual**



**VE-DWVSS**





# CONTENTS

<b>1. IMPORTANT SAFETY INSTRUCTINS</b> .....	<b>3</b>
<b>2.RECYCLING</b> .....	<b>6</b>
<b>3. INSTALLATION</b> .....	<b>8</b>
<b>4. TECHNICAL SPECIFICATIONS</b> .....	<b>9</b>
4.1. General Appearance.....	9
4.2. Technical Specifications.....	9
<b>5. BEFORE USING THE APPLIANCE</b> .....	<b>10</b>
5.1. Preparing Your Dishwasher For First Use.....	10
5.2. Setting the Water Softener.....	11
5.3. Filling the Dishwasher Salt Dispenser.....	13
5.4. Salt Refill Indicator.....	14
5.5. Detergent Usage.....	14
5.6. Filling the Detergent.....	14
5.7. Using Combined Detergents.....	15
5.8. Rinse-aid Usage.....	16
5.9. Filling the Rinse-aid and Setting.....	16
<b>6. LOADING YOUR DISHWASHER</b> .....	<b>17</b>
6.1 Upper Rack.....	18
6.2. Lower Rack.....	18
6.3. Incorrect Loads.....	20
<b>7.PROGRAMS AND OPTIONS TABLE</b> .....	<b>25</b>
<b>8.THE CONTROL PANEL</b> .....	<b>26</b>
<b>9.MAINTENANCE AND CLEANING</b> .....	<b>30</b>
9.1. Spray Arms.....	30
9.2. Cleaning The Impellers.....	31
<b>10. TROUBLESHOOTING</b> .....	<b>33</b>
<b>11.PRACTICAL INFORMATION</b> .....	<b>34</b>

**Thank you for choosing this product.**

This User Manual contains important information on safety and instructions intended to assist you in the operation and maintenance of your appliance.

Please take the time to read this User Manual before using your appliance and keep this book for future reference.

Icon	Type	Meaning
	<b>WARNING</b>	Serious injury or death risk
	<b>RISK OF ELECTRIC SHOCK</b>	Dangerous voltage risk
	<b>FIRE</b>	Warning; Risk of fire / flammable materials
	<b>CAUTION</b>	Injury or property damage risk
	<b>IMPORTANT / NOTE</b>	Operating the system correctly

## INTRODUCTION

Please read this user manual and particularly the safety instructions completely and carefully. They will save you time and effort and help to ensure optimum dishwasher performance.

Be sure to observe all listed warnings and cautions. Look particularly for the icons with exclamation marks inside. The information icon will also provide important references.

 **WARNING:** Indicates a potentially hazardous situation which, if not avoided, could result in death or serious injury.

 **CAUTION:** Indicates a potentially hazardous situation which, if not avoided, may result in injury. It may also be used to alert against unsafe practices.

 **NOTICE:** Indicates a potentially hazardous situation which, if not avoided, may result in damage to the dishwasher, the tableware, the equipment or the environment.

# 1. IMPORTANT SAFETY INSTRUCTIONS

**⚠ WARNING:** When using the dishwasher, follow basic precautions. Read all instructions before using the dishwasher! Save these operating instructions and pass them on to any future user.

- Use the dishwasher only for its intended purpose as described in this user manual. This appliance is intended for normal household use only. Do not change the specification of the appliance. **The manufacturer disclaims responsibility for damage or injury caused by improper use of this appliance.**

- The information in this user manual must be followed to minimize the risk of fire or explosion and to prevent property damage, personal injury or loss of life

- Use only detergents or wetting agents recommended for use in a dishwasher and keep them out of the reach of children.

- When loading items to be washed.

1) Locate sharp items so that they are not likely to damage the door seal, and

2) Load sharp knives with the handles up to reduce the risk of type injuries.

- Do not wash plastic items unless they are marked “dishwasher safe” or the equivalent. For plastic items not so marked, check the manufacturer’s recommendations.

- Do not touch the HEATING ELEMENT during or immediately after use.

- Do not operate your dishwasher unless all ENCLOSURE panels are properly in place.

- Do not tamper with controls.

- Do not abuse, sit on, or stand on the door or dish rack of the dishwasher.

- The cup racks are designed to support cups, glasses and kitchen utensils. When the cup racks are in the dishwasher do not lean on or use the cup racks to support your body weight.
- This appliance must be grounded. In the event of a malfunction or breakdown, grounding will reduce the risk of electric shock by providing a path of least resistance for electric current. This appliance is equipped with a cord having an equipmentgrounding conductor and a grounding plug. The plug must be plugged into an appropriate outlet that is installed and grounded in accordance with all local codes and ordinances.



### **WARNING:**

Improper connection of the equipmentgrounding conductor can result in a risk of electric shock. Check with a qualified electrician or service representative if you are in doubt whether the appliance is properly grounded. Do not modify the plug provided with the appliance, if it will not fit the outlet, have a proper outlet installed by a qualified electrician.

- Some dishwasher detergents are strongly alkaline. They can be extremely dangerous if swallowed. Avoid contact with the skin and eyes and keep children and infirm persons away from the dishwasher when the door is open. Consult a doctor immediately if detergent has been swallowed or inhaled.
- Do not remove the dishes from the appliance until the program is complete. Some detergent may remain on the dishes.
- Check that the detergent dispenser is empty after the completion of each wash program.

- Do not drink and play with the water in the appliance. harmful residues could be present.
- To reduce the risk of injury, do not allow children to play in or on a dishwasher.
- When children become old enough to operate the appliance, it is the responsibility of the parents/legal guardians to ensure the children are instructed in safe practices by qualified persons.
- Do not leave the appliance with the open door unattended to avoid stepping accidentally onto it.

 **WARNING:** Before any maintenance operation, deactivate the appliance and disconnect the mains plug from the socket.

- Do not use high pressure water sprays and/or steam to clean the appliance.
- Ensure that there are no visible water leaks during and after the first use of the appliance.
- To avoid floor damage and possible mold growth, do not allow wet areas to remain around or under the dishwasher.
- To avoid dishwasher damage, do not allow water to remain in your dishwasher systems through extended periods of freezing.

**RISK OF INJURY:** To avoid risk of injury, always use caution when opening the door during or following a wash cycle as hot water or steam may escape.

- Do not store or use flammable liquids or vapors in the area of the dishwasher, near or on the appliance.
- Under certain conditions, hydrogen gas may be produced in a hot-water system that has not been used for two weeks or more. HYDROGEN GAS IS EXPLOSIVE. If the hot-water system has not been used for such a period, before using the dishwasher turn on all hot-water faucets and let the water flow from each for several minutes. This will release any accumulated hydrogen gas. As the gas is flammable, do not smoke or use an open flame during this time.
- Please check the water supply line periodically. It is susceptible to breakage. It becomes less flexible as time goes by. Replace it immediately when it is torn, cut, swollen or there is water leakage.

## **2. RECYCLING**

Remove the door to the washing compartment when removing an old dishwasher from service or discarding it. Ensure that the appliance presents no danger to children while being stored for disposal. Before disposing the dishwasher:

- Disconnect the appliance from the mains supply.
- Cut off the mains cable and discard it.
- Remove the door catch to prevent children and pets to get closed in the appliance

Old appliances may contain materials that can be recycled. Please contact your local recycling authority about the possibility of recycling these materials.

Please check the water supply line periodically. It is susceptible to breakage. It becomes less flexible as time goes by. Replace it immediately when it is torn, cut, swollen or there is water leakage.

Please keep the dishwasher package out of the reach of children after unpacking it.



**WARNING!:**

**Risk of injury or suffocation!** Ensure that any plastic wrappings, bags, small pieces etc. are disposed of safely and kept out of the reach of children.

**SAVE THESE INSTRUCTIONS**

### 3. INSTALLATION

**⚠ WARNING:** When installing the dishwasher, follow basic precautions, including the following:  
Please check the standards and local codes for placement of machine.

- Installation, maintenance and repair should be performed by a qualified installer. Work by unqualified persons could be dangerous and may void the warranty.
- Do not operate the appliance if damaged, malfunctioning, partially disassembled or if it has missing or broken parts.
- Before installation or service, disconnect the power supply to the work area by unplugging the unit, “tripping” the circuit breaker or removing the fuse.
- Only connect the dishwasher to the power supply when all installation and plumbing work is complete.
- Never connect the ground wire to gas lines, or hot water pipes, plumbing lines.
- Do not install or store the dishwasher where it can be exposed to below freezing temperatures or exposed to weather.
- Dishwasher must be secured to adjacent cabinetry using the brackets provided. Failure to do this may cause damage to property or bodily injury.
- Connect to a properly rated, protected and sized power supply circuit to avoid electrical overload. The dishwasher is designed for an electrical supply of 120 V (volts), 60 Hz (hertz), AC, connected to a dishwasher-dedicated, properly grounded electrical circuit with a fuse or breakers rated for 15 amperes. Electrical supply conductors shall be a minimum of # 16 AWG copper wire rated at 75 °C (167 °F) or higher. These requirements must be met to prevent injury and machine damage. Consult a qualified electrician if in doubt.
- Do not use any extension cord or portable outlet device to connect the dishwasher to a power supply.

**⚠ WARNING:** Danger of suffocation! Ensure that any plastic wrap-pings, bags, small pieces etc. are disposed of safely and kept out of the reach of children.

## 4. TECHNICAL SPECIFICATIONS

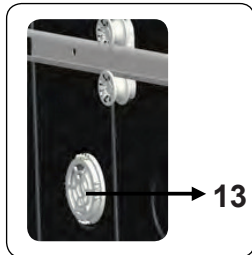
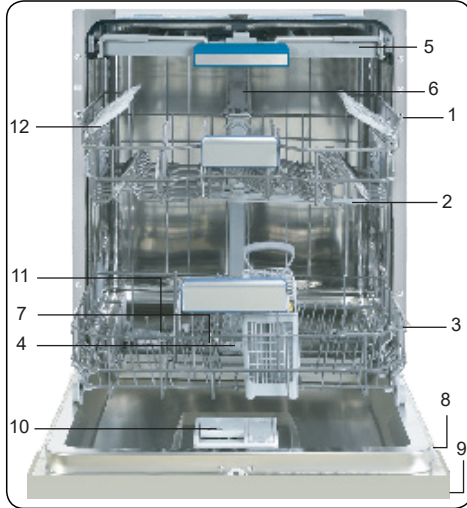

### 4.1. General Appearance

1. Upper basket with racks
2. Upper spray arm
3. Lower basket
4. Lower spray arm
5. 3rd basket( Model Depending)
6. Top nozzle( Model Depending)
7. Filters
8. Rating plate
9. Control panel
10. Detergent and rinse-aid dispenser
11. Salt dispenser( Model Depending)
12. Upper basket track latch
13. Drying Unit: This system provides better drying performance for your dishes.

## 4.2 Technical Specifications

Permissible water pressure	43.5-145psi (0.3 - 10 bars)
Electrical connection	120 V (volts), 12 A (amps), 60Hz (hertz)
Total power	1400 (W)
Heater power	1100 (W)

 **NOTICE:** Because we continually strive to improve our products, we may change our specifications and design without prior notice. This device corresponds to the following directives:  
UL 749 Household Dishwasher directive.

## 5. BEFORE USING THE APPLIANCE

### 5.1 Preparing Your Dishwasher For First Use

- Make sure the electricity and supply water specifications match the values indicated in the installation instructions for the machine.
- Open the door of the dishwasher.
- Remove all packaging material inside the machine.
- Set the water softener level. (See chapter of setting the water softener) (model depending).
- Set the rinse aid dosage (See chapter of filling the rinse-aid and setting).
- Fill the salt container (see chapter of filling the dishwasher salt dispenser) (model depending).
- Fill the rinse aid compartment. (See chapter of filling the rinse aid and setting).
- Place the dishes in accordance with the instructions in the user manual.
- Put adequate amount of detergent into the detergent dispenser. (See chapter of filling the detergent).
- Make sure that the upper and lower impellers rotate freely.
- Select program according to amount of dirt (See chapter of Program table).
- Close the door of the dishwasher. (Push the baskets in. Then lift the door upwards and push until it clicks into position).

 **CAUTION:** To prevent injuries, ensure that your hand is not jammed or crushed between the door and appliance

 **WARNING:** While the appliance is running if you open the door all functions are automatically interrupted

 **CAUTION:** There may be an escape of hot steam when you open the door of your machine. Be careful of getting injured.

### 5.2. Setting the Water Softener ( Model Depending )

Dishwasher needs soft water for good cleaning results. Hard water results in a build-up of calcium deposits on dishware and in the dishwasher. Your dishwasher has a special water softening system to remove the hardness of the tap water. Setting this system correctly will increase the washing effectiveness.

Water supplies with a hardness level higher than 9 °f (French Water Hardness) needs to be softened.

If the hardness level of the water that you use is above 9 °f (French standard for water hardness) or if you are using well water, than it is recommended to use filter and water purification devices.

The dishwasher is programmed at the factory setting level 1 (inactive) of water hardness. If this setting corresponds to the hardness of your water, you do not need to do anything more.











The dishwasher must be programmed for the water hardness in your area.

To find out the hardness level of water in your area, contact your local Water Board or Determine water hardness level by the help of test strip provided.

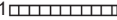
 **WARNING:** If you move to a different location, the level of water hardness will possibly be different. It is essential to setting again the water hardness in order to obtain optimum washing efficiency.

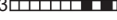
## Test Strip ( For Models With Water Softener )

The washing effectiveness of your machine depends on the softness of the tap water. For this reason, your machine is equipped with a system that reduces the hardness in mains water supply. The washing effectiveness will increase when the system is correctly set. To find out the water hardness level of water in your area, contact your local water board or determine water hardness level by using the test strip(if available). Follow step in the image when use the test strip.

	Run water through the tap (1min.)	Keep the strip in the water (1sec)	Shake the strip.	Wait (1min.)	Set the hardness level of your machine.
					1  2  3  4  5  6 

**⚠ WARNING:** If the water is well water or has a hardness level above 9 °f, we recommend that you use filter and refinement devices.

## Water Hardness Table

Level	German °dH	French °f	British °E	Indicator
1	0-5	0-9	0-6	L1 is shown on the display.
2	6-11	10-20	7-14	L2 is shown on the display.
3	12-17	21-30	15-21	L3 is shown on the display.
4	18-22	31-40	22-28	L4 is shown on the display.
5	23-31	41-55	29-39	L5 is shown on the display.
6	35-50	56-90	40-63	L6 is shown on the display.

Adjust the water hardness setting of your machine according to the level specified on the test strip (if available).



**NOTE:** Hardness level is adjusted to level 1 as a factory setting.



**NOTE:** If you only ever use combination products in your dishwasher, you can change the softener level.

## Salt Indicator

Please check the salt indicator on the control panel to see whether there is adequate amount of softening salt in the dishwasher or not. You need to refill the salt reservoir with salt whenever salt warning indicator appears on the control panel of your machine. In order to add salt to the machine,

1. Open the door of the machine,
2. Press and hold "Start/Pause + On/Off" key for 3 seconds,
3. The machine gives an audible warning when it is ON,
4. Then, press and hold "Program Selection + Cancel" key until "SL" is represented on the display, display, the machine will display the last setting,
5. The amount of Salt is adjusted by pressing "Program Selection + Cancel" key,
6. After the adjustment, turn off (by pressing Start/Pause + On/Off key) the machine to save the selected salt amount.

### 5.3 Filling The Dishwasher Salt Dispenser ( Model Depending)

**⚠ WARNING:** Culinary and table salts do not dissolve in water easily, using these kind of salts will damage water softener system in your machine.

**👤 NOTE:** Machine can only be used by special dishwasher salt to soften the water. Do not use any small grained or powdered type of salts which can easily soluble. Using any other type of salt can damage your machine. The manufacturer is not liable for damages result-ing from the use of the wrong type of salt

**⚠ WARNING:** Dishwasher detergent will damage the softener assembly. Do not fill the salt container with dishwasher detergent.

**⚠ WARNING:** If the water in your area is very soft and consistently lower than 9°f (French Water Hardness) you do not have to add dishwasher salt.

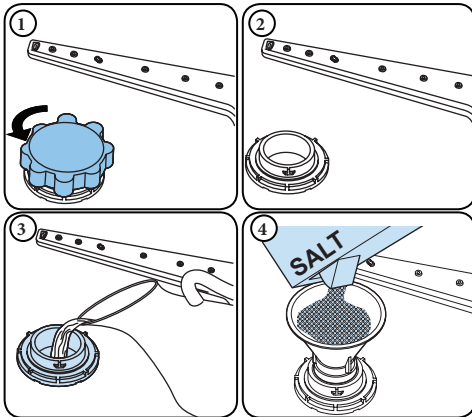

1. To put softener salt, first remove the lower basket and then open the salt compartment cap by turning it counter clockwise. (fig 1-2)
2. Add first fill the compartment with 1kg salt and water (fig 3) at overflowing level If available,using the funnel (fig 4) provided will make filling easier.
3. Refit the cap and close it.

**⚠ WARNING:** Starting the machine with any wash program is recommended after filling the salt container, in case of any spilled salt solutions. This prevents damage to the machine.

**👤 NOTE:** Fill the salt compartment with water only for the first time you fill the salt compartment.

**👤 NOTE:** If the salt warning lamp on the control panel illuminates fill the salt compartment with salt again.

**⚠ WARNING:** Use softener salt specifically produced for use in dishwashers .

**⚠ WARNING:** If you switch to using detergent that does not contain salt or rinse aid, it is important to remember to add dishwasher salt and rinse aid.

### 5.4. Salt Refill Indicator (Model Depending)

**⚠ WARNING:** If the salt indicator light comes on during a program you need to wait until the end of the program to fill the salt reservoir with dishwasher salt. After the salt reservoir has been filled, the refill indicator may still be lit up if the salt concentration has not yet reached the correct level. It will go out when the correct concentration is reached.

**👤 NOTE:** The salt refill indicator will be turned off if you have programmed the dishwasher for a water hardness below 9 °f.

## 5.5. Detergent Usage

**⚠ WARNING:** Use a detergent specifically designed for use in domestic dishwashers.

You can find powder, gel, and tablet detergents in the market that have been designed for household dishwashers. Detergent should be put into the compartment prior to starting the machine. Add the proper detergent for the selected program to ensure the best performance. Use less detergent if the dishes are only lightly soiled. Using excess detergent can leave a film on dishes and in the dishwasher resulting in poor wash performance. Do not use detergent tablets for shorter wash cycles. The tablet may not dissolve completely, causing detergent residue on dishes and inefficient cleaning.

**👤 NOTE:** The amount of detergent needed depends on the cycle, load size, and soil level of dishes. Too much detergent in soft water may cause glass corrosion and does not dissolve in water.

**⚠ WARNING:** Do not use too much detergent if your water supply is soft.

**⚠ WARNING:** Keep your detergents in cool, dry places out of reach of children. See the detergent manufacturer's instructions for further information.

**⚠ WARNING:** Detergent tablets do not fully dissolve with short programmes. To prevent detergent residues on the tableware, we recommend that you use the tablets with long programmes.

**⚠ WARNING:** Do not use detergent in Rinse cycle (model depending). If you do not know the hardness of your water supply, use 15 ml / 3 tsp detergent. Increase the amount of detergent if you see white water marks especially on the surface of the glassware.

Should you need more information concerning the detergent you will use, contact detergent manufacturers directly.

Check that the detergent dispenser is empty after the completion of each wash program

## 5.6. Filling The Detergent

**👤 NOTE:** The dispenser should be refilled just before the start of each program.

1. Push the latch to open the detergent container as shown in the image (fig 1).

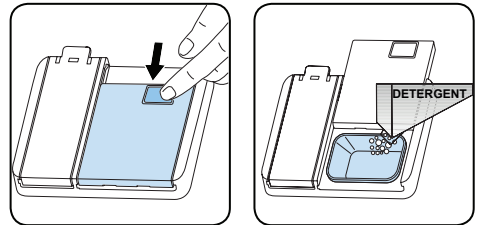

2. Pour/put the detergent into the dispenser. ( fig 2)

3. Detergent pod has level lines inside. It is possible to measure the right detergent amount using these lines. Detergent pod can take totally 40 cm<sup>3</sup> detergent. Open the dishwasher detergent and pour into the larger compartment 25 cm<sup>3</sup> if your dishes are heavily soiled or 15 cm<sup>3</sup> if they are less soiled. You may have to add more detergent into your machine, depending on the degree of soil and on the water hardness level in your area.

4. Close the flap of dispenser.

**👤 NOTE:** The flap is always open at the end of a program.

**⚠ WARNING:** Follow instructions on the package of the detergent when using liquid dishwasher detergent, concentrated powder detergent, or tablet detergent.



**⚠ WARNING:** Amounts may vary if you use liquid or concentrated powder detergent. Tablet detergents should be placed in detergent container.

**⚠ WARNING:** Deviations are possible depending on how dirty the dishes are and how hard the water is in your location.

**⚠ WARNING:** Use only the proper amount of detergent. Continued use of too much detergent may cause machine damage.

## 5.7. Using Combined Detergents

Detergent manufacturers also manufacture combined detergents that are called 2 in 1 – 3 in 1-5 in 1...

The 2 in1 detergents contain detergent+salt or rinse aid . While using the 2 in 1 detergents, it should be observed which functions the tablet consists of.

The other tablet detergents also have detergent+rinse aid +salt+various extra functions.

Generally, combined detergents produce sufficient results under certain usage conditions only. Such detergents contain rinse aid and/or salt in preset amounts.

### Points to consider when using this type of products:

- Always make sure to check the specifications of the product you will use or whether or not it is a combined product.
- Check if the detergent used is appropriate for the hardness of mains water that machine is pertaining to.
- Observe the instructions on packagings when using such products.
- If such detergents are in the form of tablets, never put them into the interior section or the cutlery basket of the dishwasher. Always put the tablets into the detergent compartment in the detergent dispenser.

- They produce good results for certain types of usage only. If you are using this type of detergents, you need to contact the manufacturers and find out about the suitable conditions of use.
- When the conditions of use of such products and the machine settings are appropriate, they ensure savings in salt and/or rinse aid consumption.
- Contact the detergent manufacturers if you are not obtaining good wash results (if your dishes stay calcareous and wet) after having used 2 in 1 or 3 in 1 detergents. The scope of warranty for your machine does not cover any complaints caused by the use of these types of detergents.

**Recommended usage:** If you want to obtain better results while using combined detergents, add salt and rinse aid into your machine and adjust the water hardness setting and the rinse aid setting to the lowest position.

**⚠ CAUTION:** Solubility of the tablet detergents produced by different companies can vary depending on the temperature and time. Therefore, it is not recommended to use such detergents in short programs. It is more suitable to use powder detergents in such programs.

**Warning:** Should any problem, which you have not encountered before, arise with the use of this type of detergents, contact the detergent manufacturers directly.

### When you give up using combined detergents

- Fill the salt and rinse aid compartments.
- Adjust the water hardness setting to the highest position and run an emptywash.
- Adjust the water hardness level.
- Make the suitable rinse aid setting.

## 5.8. Rinse - aid Usage

Rinse-aid makes dishes sparkle and helps them to dry without spotting. Rinse-aid is required for stain-free utensils and clear glasses.

(!) Use only rinse-aid for domestic dishwashers.

(!) Filling the rinse aid reservoir with detergent will damage the reservoir. Only pour rinse aid formulated for residential dishwashers into the reservoir.

**NOTE:** When the Rinse Aid indicator lights up, the rinse aid reservoir contains sufficient rinse aid for 2 - 3 programs only. When using "Tab" detergents rinse aid is not needed.

## 5.9 Filling The Rinse-aid and Setting

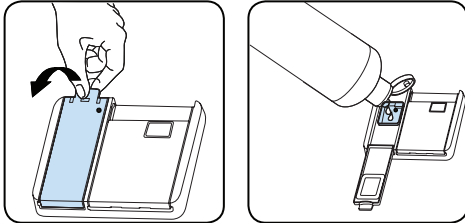

- 1) To fill the rinse aid compartment, open the rinse-aid compartment cap (Fig.A)
- 2) Fill the compartment with rinse aid to the MAX level and then close the cap. Be careful not to overfill the rinse aid compartment and wipe up any spills.
- 3) Close the cap until it click. Otherwise water can enter the rinse aid reservoir during a program.

**In order to change the rinse aid level, follow the below steps before turning on the machine**

In order to add rinse aid to the machine,

1. Open the door of the machine,
2. Press and hold "Start/Pause + On/Off" key for 3 seconds,
3. The machine gives an audible warning when it is ON,
4. Then, press and hold "Program Selection + Cancel" key until "rA" is represented on the display, the machine will display the last setting,
5. The amount of rinse aid is adjusted by pressing "Program Selection + Cancel" key,
6. After the adjustment, turn off (by pressing Start/Pause + On/Off key) the machine to save the selected rinse aid amount.

**NOTE:** If the dishes are not drying properly or are spotted, increase the level if blue stains form on your dishes, decrease the level.

Level	Brightener Dose	Indicator
1	Rinse - aid not dispensed	r1 is shown on the display.
2	1 dose is dispensed	r2 is shown on the display
3	2 doses are dispensed	r3 is shown on the display.
4	3 doses are dispensed	r4 is shown on the display.
5	4 doses are dispensed	r5 is shown on the display.

## 6. LOADING YOUR DISHWASHER

If you properly place your dishes into the machine, you will be using it in the best way in terms of energy consumption, washing and drying performance.

You can load into the lower basket such round and deep items as pots with long handles, pot lids, plates, salad plates, cutlery sets. The upper basket has been designed for dessert plates, salad bowls, cups and glasses. When placing long stem glasses and goblets, lean them against the basket edge, rack or glass supporter wire and not against other items. Do not lean long glasses against one another or they cannot remain steady and may receive damage. It is more appropriate to locate the thin narrow parts into the middle sections of baskets. You can place spoons among the other cutlery sets in order to prevent them from sticking to one another.

You are recommended to use the cutlery grid in order to obtain the best result. To avoid any possible injuries, always place such long-handle and sharp-pointed dishes as serving fork, bread knife etc. with their sharp points facing down or horizontally on the baskets.

 **WARNING:** Place your dishes into your machine in a way that they will not prevent the upper and lower spray arms from spinning.

 **NOTE:** Place all large and very dirty items in the lower rack.

 **WARNING:** Do not put in the appliance items that can absorb water (sponges, household cloths).

 **NOTE:** Place all containers such as cups, glasses and pots into the dishwasher with the opening facing downwards (so that no water can collect).

 **NOTE:** Dishes and cutlery should not be placed above each other.

 **NOTE:** Do not overload your dishwasher and pay attention to manufacturer instructions regarding dishes

which are appropriate for use in a dishwasher. Only with suitable dishes (mentioned in section 5) will you obtain optimal washing results with a sensible use of energy.

High temperature water and dishwasher detergent may form a chemical synthesis that can damage certain items.

 **WARNING:** Be careful when loading and unloading sharp items. Load sharp knives with the handles up to reduce the risk of personal injury.

Follow the below steps before loading dishwasher.

1. Open the door.
2. Remove coarse food leftovers from tableware.
3. Load the dishwasher.

 **NOTE:** While the appliance is running if you open the door all functions are automatically interrupted. Once the door is closed functions will continue to work.

## 6.1 Upper Rack

Load the upper rack with dessert plates, cups, glasses etc.

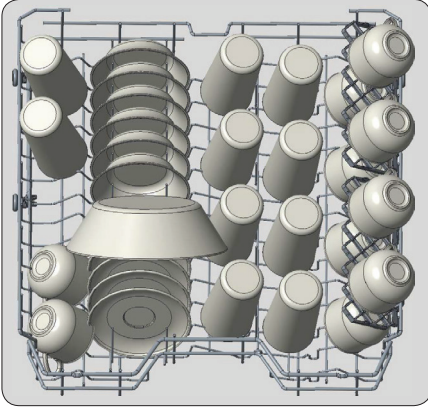

Top rack load pattern for 10 place settings.

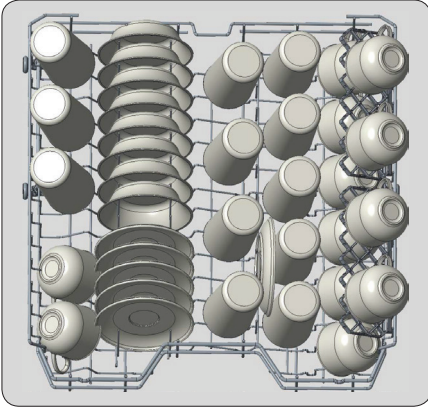

Additional Loading Pattern 12 place settings

## 6.2. Lower Rack

You can load into the lower basket such round and deep items as pots with long handles, pot lids, plates, salad plates, cutlery sets. The lower rack should not be used for small items such as cups, wine glasses.

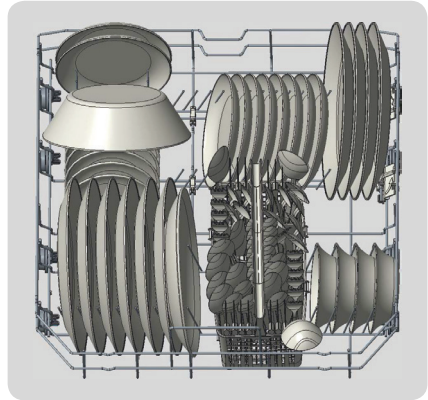
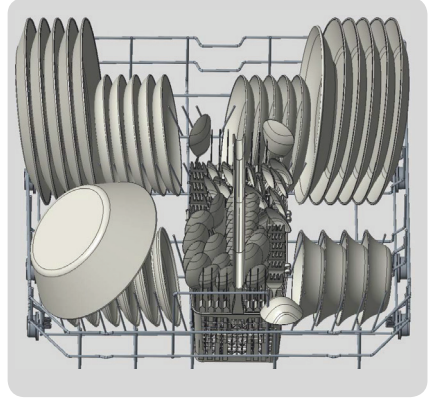

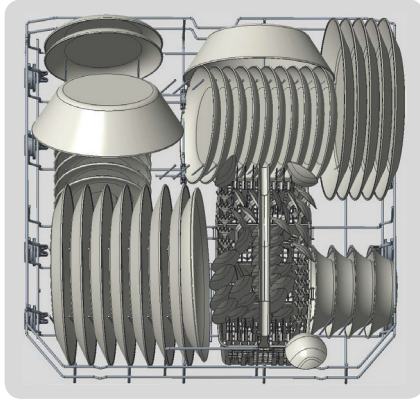
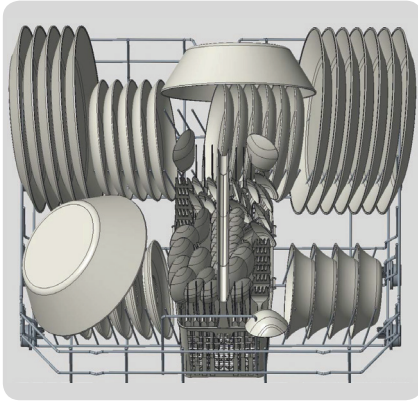

Bottom rack load patterns for 10 place settings.



Bottom rack load patterns for 12 place settings.

 **NOTE:** Place all large and very dirty items in the lower rack.

 **WARNING:** Large knives and other utensils with sharp tips and edges must be placed horizontally into the upper rack due to risk of injury. Other smaller knives and sharp utensils should be placed with sharp side down in the cutlery basket.

 **NOTE:** Make sure that large items do not interfere with the rotation of the spray arms, and do not prevent the detergent dispenser from opening.

**Loading cutlery basket  
( Model Depending )**

1: Salad Fork  
2: Teaspoon  
3: Dinner fork  
4: Knife-solid handle  
5: Serving spoon 6:  
Serving fork

6	4	4	4	4	4	4	4	4	4	4	4
				2	2						
				2	2						
3	1	2	2	2	1	3					
3	1	2	2	2	1	3					
3	1	2	2	2	1	3					
3	1	2	2	2	1	3					
3	1	2	2	2	1	3					
				2	2						
				2	2						
				2	2						
				2	2						
5	4	4	4	4	4	4	4	4	4	4	5

Cutlery Basket load pattern for 12 place settings .

**⚠ WARNING:** Sharp cutlery may have shifted position during the wash operation and can be also wet and slippery. Carefully remove them to prevent injury.

**👉 NOTE:** Small items should therefore be placed in the cutlery tray or cutlery basket (model depending). Because small items can fall through the holders from the baskets.

**6.3. Incorrect Loads**

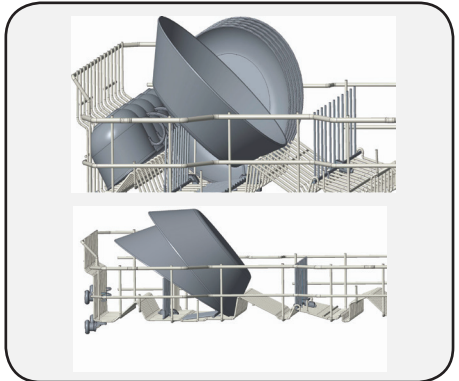
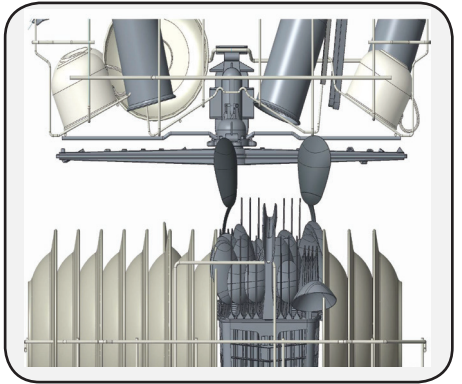
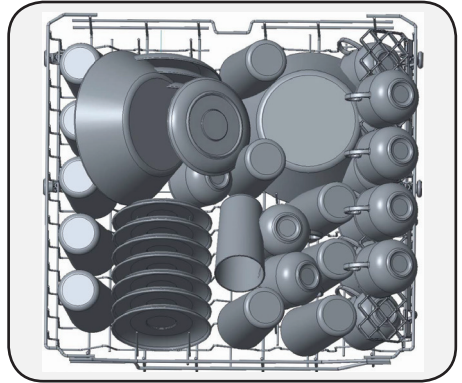

## Top Basket

### Rack with height adjustment

These racks are designed to increase the capacity of top basket. You can place your cups and glasses on these racks. Thanks to adjustable feature of the racks, you can place glasses of different sizes under the racks.

Height adjustment plastics mounted on the basket allow racks to be in 2 different positions.

You can also place long knives, forks and spoons on these racks horizontally for them not to block the movement of spray arms

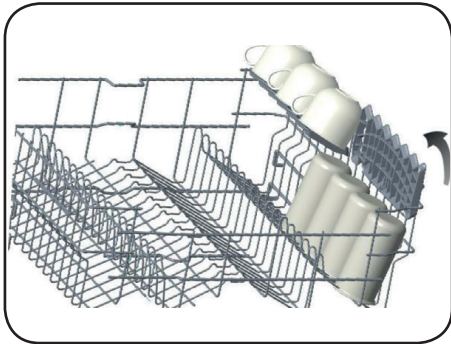
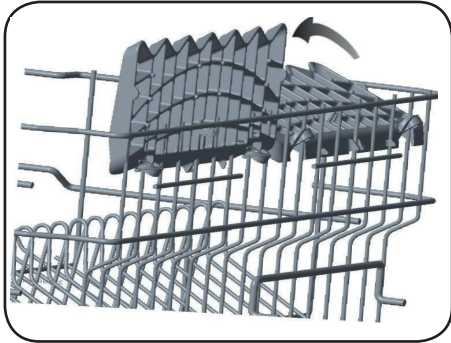
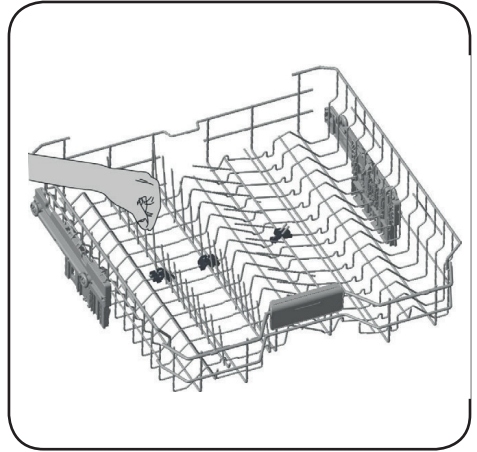

Top basket horizontal wire located on top basket allows you to place your plates and bowls where required. Also you can wash kitchenware such as pan or pot by closing the horizontal wire.



**NOTICE:** Bringing the wires to the horizontal position by holding them from the tips may cause them to bend. Therefore, it will be appropriate to bring the wires in the middle to horizontal or vertical position by holding them from their stems and pushing.

The basket height adjustment mechanism on the top basket of your machine is designed to let you adjust the height of your top basket upwards or downwards, without removing it from your machine when it is full, and create large spaces at the top or bottom area of your machine as needed. Basket of your machine is set to upper position in factory settings. In order to raise your basket, hold it from both sides and pull it upwards. In order to lower it, hold it from both sides again, and leave it. In loaded basket adjustment mechanism, make sure that both sides are in the same position. (up or down)



**NOTICE:** Make sure that both levers catch in the same height position.

## Height Setting ( Model Depending )

### 1) Height setting - when basket is empty ( model depending )

In certain models, the height setting of the upper rack may be changed using the wheels which are present at two height levels.



**CAUTION:** Make sure that the rack is empty. Changing the height setting while the rack contains tableware could cause the contents to dislodge, causing personal injury or damage to the tableware.

1. Release the latches on both the right and left tracks of the upper rack by turning them to the outside A.

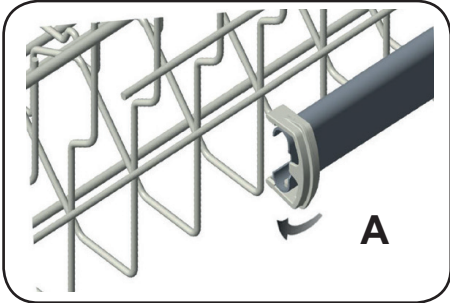

2. Pull out the rack completely B.

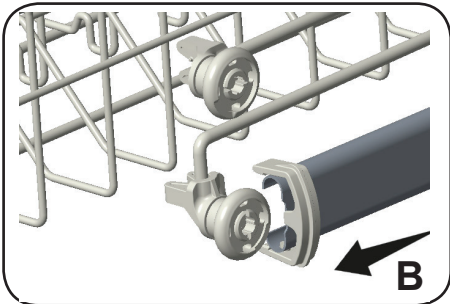

3. Place the rack into the tracks again at the desired height C.

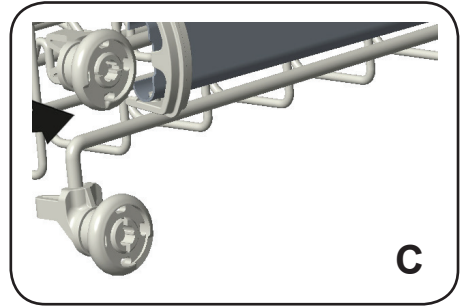

4. Push the latches back into the correct position.



## 2) Height setting - when basket is filled ( model depending )

The upper basket includes a mechanism which enables the height of the basket to be adjusted up (1) or down (2) without having to remove the basket. Hold the basket on both sides and pull it up or push it down, ensuring both sides of the upper basket are in the same position.

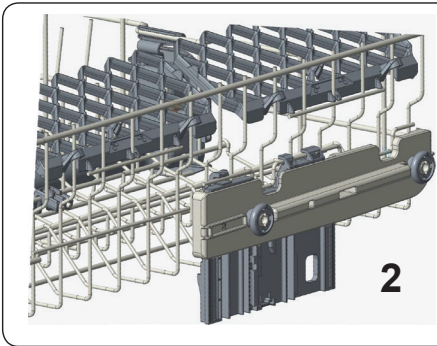
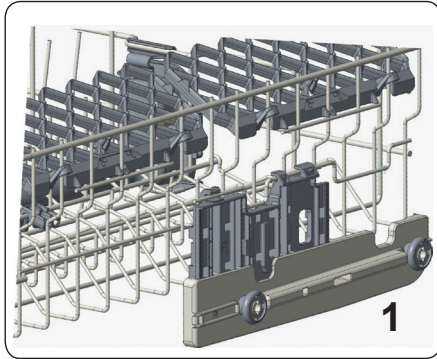
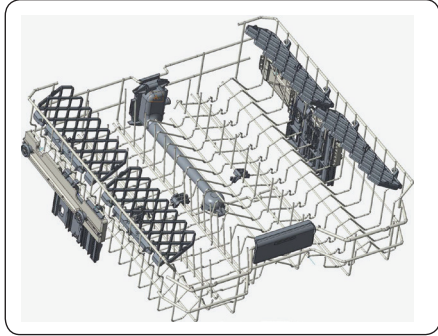

## Lower Basket Folding Racks

Folding racks consisting of four parts that are located on the lower basket of your machine are designed in order to let you place big items easier such as pots, pans, etc. If requested, each part can be folded separately, or all of them can be folded and larger spaces can be obtained. You can use folding racks by raising them upwards, or by folding.

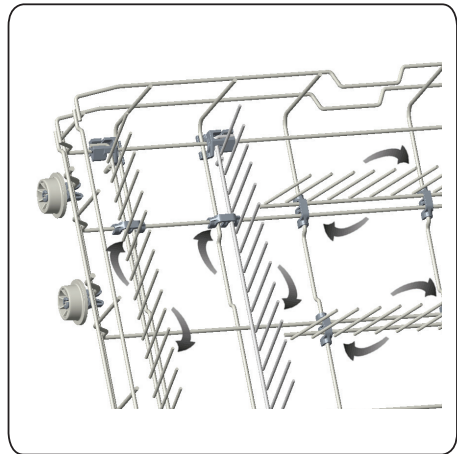
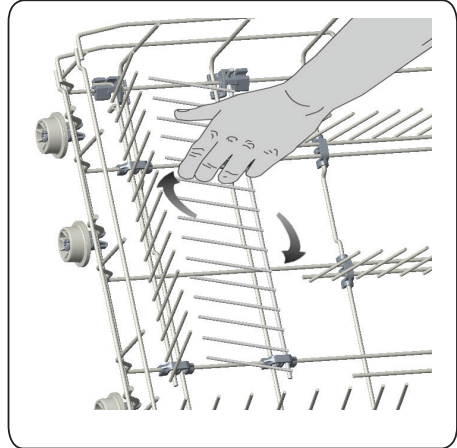

## Upper Cutlery Basket ( Model Depending )

The upper cutlery basket is designed for the placement of large and small cutlery and utensils.

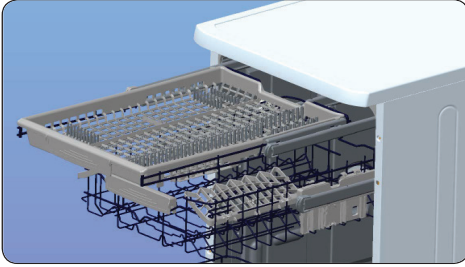

It is easily removed from the dishwasher, therefore allows ease of use when removing your items, along with the basket, after washing.

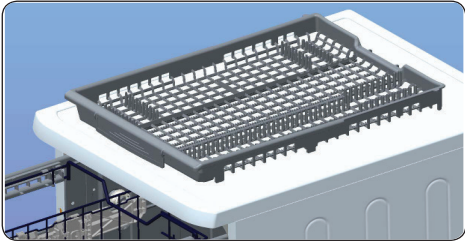

**WARNING:** Knives and other sharp objects must be placed horizontally in the cutlery basket.

## Silverware Basket (Model Depending)

Silverware basket is designed to wash your dishes such as knife, fork, spoon, etc. in a cleaner manner.

Since the cutlery basket can be moved , you can create a wider space while placing your dishes to the lower basket and free up space for your dishes in different sizes.

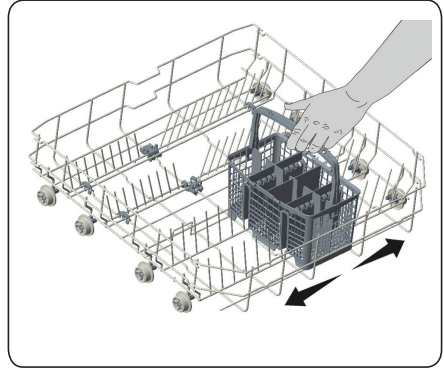

## 7. PROGRAMS AND OPTIONS TABLE

Programs		Duration (min)	Descriptions
Regular	Dirty	145	Standard program for daily, regular or typical use to completely wash a load of normally soiled dishes.
	Clean	122	
Auto	Dirty	155	This program automatically adjusts the temperature and the quantity of water, the energy consumption and the program duration.
	Clean	110	
Intensive Plus		165	Suitable for heavily soiled dishes that are kept waiting.
Intensive		130	Suitable for heavily soiled dishes.
Daily		117	Suitable for normally soiled daily dishes.
Delicate		90	Suitable for lightly soiled delicate dishes.
Super		50	Suitable for normally soiled daily dishes with faster program.
Rinse		15	Suitable to rinse dishes that you plan to wash later.

Compatibility of Programs and Options		Options			
		Half Load	Extra Dry	Sanitize	Hi-Temp
Programs	Regular	✓	✓	✓	✓
	Auto	✓	✓	✓	✓
	Intensive Plus	✓	✓	✓	✓
	Intensive	✓	✓	✓	✓
	Daily	✓	✓	✓	✓
	Delicate	✓	✓	X	X
	Super	✓	✓	✓	✓
	Rinse	✓	X	X	X

**NOTE:** The program duration may change according to the amount of dishes, the water temperature, the ambient temperature and selected additional functions.

**NOTE:** The energy-usage label is based on the “Regular” program. This program is the most efficient in terms of its combined energy and water consumption at cleaning normally soiled dishes.

- Only use powder detergent for short programmes.
- Short programmes do not include drying.
- To assist drying, we recommend slightly opening the door after a cycle is complete.

### Water Temperature

Hot water is needed for best dishwashing and drying results. Water entering dishwasher should be at least 120°F (49°C) to give satisfactory results.

To check water temperature entering dishwasher:

- Turn on hot water faucet nearest dishwasher for several minutes to clear cool water from pipes.
- Hold a candy or meat thermometer in stream of water to check the temperature.
- If temperature is below 120°F (49°C), have a qualified person raise the hot water heater thermostat setting.

## 8. OPERATING THE PRODUCT

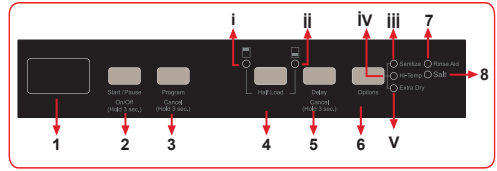

1. Display
2. On/Off + Start/Pause Key
3. Program Selection + Cancel Key
4. Half Load Key
  - i. Upper Basket Half Load Led
  - ii. Lower Basket Half Load Led
5. Delay Timer Key
6. Options Key
  - iii. Sanitize Function Led
  - iv. Hi-Temp Function Led
  - v. Extra Dry Function Led
7. Rinse Aid Indicator
8. Salt Indicator

### 8.1. Keys

#### On/Off Key

This key is used as On/Off key if the corresponding button is held down for 3 seconds. Otherwise, it can be used as Start/Pause key. It is used to turn on or turn off the machine. Machine will turn on with Regular program and the number and the duration of the regular program will appear on the display. Each of program number and the duration will sequentially represent for 2 seconds on the display. In Off position, the display will turn off.

#### Start/Pause Key

It is used to start or pause a selected program and functions.

#### Program Selection/Cancel Key

It is used to select the washing program you determined from the programs table.

The cancel key is activated when Program Selection/Cancel Key is held down for 3 seconds.

### **Half Load Key**

It is used to add Half Load functions to the selected program.

### **Delay Timer Key**

It should be pressed to make the time delay settings.

### **Options Key**

It is used to add auxiliary functions to the selected program.

## **8.2. Preparing The Machine**

1. Open the door of the dishwasher.
2. Place the dishes in accordance with the instructions in the user manual.
3. Make sure that the upper and lower impellers rotate freely.
4. Put adequate amount of detergent into the detergent dispenser.
5. Check if the Salt and Rinse Aid indicators light and add salt and/or rinse aid if needed.

## **8.3. Program Selection**

1. Press the On/Off key to turn on your machine. Note that the door of the dishwasher is OPEN position.
2. Refer the "Programs Table" to determine a washing program suitable of your dishes.
3. Press program selection key until the number of the program you selected appears on the display.

In order to start the selected program, Start/Pause key must be pressed and the door of the dishwasher must be closed within 4 seconds after the Start/Pause key is pressed.

If the door is not closed within 4 seconds, the machine will not start. In this case; to start the selected program, the door must be opened, the Start/Pause key must be pressed and the door must be closed again within 4 seconds after the Start/Pause key is pressed.

If the door of the machine is opened when the machine is running, the machine stops working. If the door is closed back within 4 seconds after the door is opened, the machine will continue.

If the door stays open for more than 4 seconds, Start/Pause key must be pressed and the door of the dishwasher must be closed within 4 seconds after the Start/Pause key is pressed.

## **8.4. Auxiliary Functions**

Washing programs of your dishwasher are designed to obtain the best cleaning effect, considering the type of the soil, soiling degree and properties of the dishes to be washed. Auxiliary functions are provided in order to enable you to save time, water and energy and to perform a more comfortable washing with conditions specific to you.

- i. Auxiliary functions may cause changes in the program duration.
- ii. Auxiliary functions are not suitable for all washing programs. Indicator of the auxiliary function that is not compatible with the program will not be active. Besides, the machine gives aural warning via buzzer.

### **To add auxiliary function to the program:**

1. Select the desired washing program by pressing the Program Selection key.
2. In the selected washing program, if auxiliary function is selected, the corresponding function led will be on. If the Half Load or Options key is pressed again, the corresponding led of another auxiliary function will be on.
3. The selection of the auxiliary function will be cancelled when you press the Half Load or Options button until the selected option led becomes off.

### **Sanitize Function**

Sanitize function raises the water temperature in the final rinse.

- i. At the end of a successful sanitization, "--" is displayed on the display and End of program indicator will be active.

ii. "Available programs and options are indicated on program Table and Options Table charts

### Hi-Temp Function

When this option is selected, both the water temperature and the washing time are increased.

### Extra Dry Function

The machine changes the water temperature from the value described for each different program and the extra dry is performed.

### Half Load Function

It is used to operate the machine without loading it completely.

1. Load your dishes in the machine as you like.
2. Turn the machine on with On/Off key.
3. Select the desired program and press the Half Load key. The Half Load indicator will light on the display.
4. Press Start/Pause key to start the selected program and close the door of the machine.
5. With the Half Load function you can save power while using the lower and/or upper baskets of the machine.

## 8.5. Programming The Washing Time

### Delay Timer

If an economical electricity tariff is applied in your region, you can use the Delay Timer function to wash your dishes during appropriate hours. You can delay the start of the selected program until 19 hours. Delay Timer cannot be set after the program starts.

1. Press the Delay Timer function key after selecting the washing program and other auxiliary functions.
2. Once you press the Delay Timer key, Display will show "1h" and Display will show program number, program duration and delay time alternately for 2 seconds.
3. Set the desired time by pressing the Delay Timer key. Time will increase with the

increments of 1 hour every time you press the key.

4. In order to start the selected program with delay, Start/Pause key should be pressed and the door of the dishwasher must be closed within 4 seconds.



**NOTE:** The use of Delay Timer has a special case.

a. Assume that you have selected a program with delay and pressed Start/Pause key. After a length of time, you have opened the door of the machine. If the door of the machine is closed within 4 seconds, the machine resumes on for the duration of delay timer. This is also valid if the door of the machine is not closed within 4 seconds.

### Changing the settings while Delay Timer is enabled

While the Delay Timer function is activated, you cannot make changes in the washing program, auxiliary functions or the duration of delay time.

i. Program and auxiliary functions cannot be set/changed after the program has started.

### To cancel the Delay Timer function

1. Open the door of the dishwasher
2. Press and hold program Delay Timer key for 3 seconds
3. At the end of 3 seconds delaying process will be cancelled.
  - i. You can select and start a new program following the cancellation of Delay Timer function.
  - ii. Delay Timer function can not be set after the program starts.

## 8.6. Starting The Program

First of all, open the door of your machine and in order to start your machine after selecting the program and auxiliary functions, Start/Pause + On/Off key. Once the program starts, the estimated time remained to the end of the program will appear on the display.

i. Your machine performs water softening depends on model hardness level of the supply water (Model depending). Remaining time displayed towards the end in some programs can be different from the time indicated at the beginning due to this process. The total time can also change while the program is running depending on the ambient temperature where your machine is installed, temperature of the supply water and amount of the dishes.

ii. Pay attention not to open the door of the machine when it is running. Stop the machine by pressing Start/Pause key as soon as the door of the machine is opened. In other situation, the machine will stop automatically after 4 seconds when the door of the machine is opened and any key is not pressed. To start a program, Start/ Pause key is pressed and close the door of the machine within 4 seconds.

iii. If the door is opened while the machine is running, the machine will switch to the standby mode. Press Start/Pause key and close the machine door within 4 seconds, then the program will resume.

## 8.7. Child (Key) Lock

Not available.

## 8.8. Cancelling The Program

1. Press program Selection + Cancel key for 3 seconds to cancel the program.

2. After 3 seconds, "1" will appear on the display. For a couple of minutes the machine will fulfill the necessary operations required to cancel the program.

i. There might be residues of detergent or rinse aid left in the machine and/or on the pieces being washed depending on the step the program you have cancelled was in.

## 8.9. Salt Indicator( Model Depending )

Please check the salt indicator on the control panel to see whether there is adequate amount of softening salt in the dishwasher or not. You need to refill the salt reservoir with salt whenever salt warning indicator appears on the control panel of your machine.

## 8.10. Rinse Aid Indicator

Please check the rinse aid indicator on the control panel to see whether there is adequate amount of rinse aid in the dishwasher or not. You need to refill the rinse aid reservoir with rinse aid whenever rinse aid warning indicator appears on the control panel of your machine.

## 8.11. End of Program

"00" will be displayed when the washing programme is over.

1. Open the door of the machine.  
2. Press Start/Pause + On/Off key to turn off your machine.

3. Close the tap.

4. Unplug the machine from the socket.

i. Leave your dishes in the machine for about 15 minutes to cool down after they are washed. Your dishes will dry in a shorter time if you leave the door of your machine ajar during this period. This process will increase the drying effectiveness of your machine.

## 8.12. Water Cut - Off Warning

If mains water is cut or water inlet tap is turned off the machine can not take water in and "FF" will flash continuously on the display. As long as the problem continues, the washing program is stopped and water inlet is checked regularly by the user. If the water inlet is provided, the machine gets ready to start a new program.

## 8.13. Overflowing Warning

If the machine intakes too much water or there is leakage at any of the components then the machine will detect this and "F1" will flash on the display. As long as the overflowing continues, safety algorithm will be active and try to discharge the water. If overflowing stops and safety is assured, "F1" will disappear. If "F1" does not disappear,

there is a permanent fault. In this case, the authorized service should be contacted.

## 9. MAINTENANCE AND CLEANING

**⚠ WARNING :** Before cleaning or carrying out maintenance, switch off the appliance, disconnect the mains plug and turn off the water tap.

Your dishwasher can only be repaired by an authorized service agent. Do not try to repair your machine unless any recommendation by this manual

**⚠ WARNING :** All surfaces are susceptible to scratching. Contact with unsuitable cleaning agents can alter or discolor all surfaces.

**⚠ WARNING :** Keep the floor around your dishwasher clean and dry to prevent any possible injury. We recommend to keep your dish washer clean, empty and door cracked open to allow air to circulate in case of any extended unused time.

Dishwasher door can be damaged by abrasive cleaners, scouring pads, abrasive cloths. Cleaning the machine in regular intervals prolongs the machine's service life. Oil and lime may accumulate in the machine's washing section. In case of such accumulation; -Fill the detergent compartment without loading any dishes into the machine, select a program that runs at high temperature, and start the machine. In case of insufficiency, use special cleansing material available in the market. (Cleansing material produced special to machines by detergent producers.)

Cleaning the seals in the machine door, - To clean any accumulated residues in the door seals, wipe the seals regularly by using a dampened cloth.

Cleaning the machine, Clean the filters and spray arms at least once a month.

Unplug your machine and turn off its tap before starting the cleaning.

Do not use hard materials when cleaning your machine. Wipe with a fine cleaning material and a dampened cloth.

Filters

Check if any food wastes have remained on the coarse and fine filters. If any food wastes are left, remove the filters and clean them thoroughly under the water tap.

### Filter

- a. Micro Filter
- b. Coarse Filter
- c. Metal/Plastic

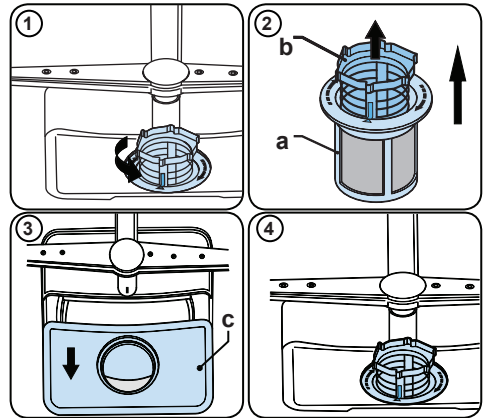

### 9.1. Spray Arms

Check whether or not the holes for the upper and lower spray arms are clogged. If there is any clogging, remove the spray arms and clean them under water.

You can remove the lower spray arm by pulling it upwards, while the upper spray arm nut can be removed by turning the nut to the left.

Be sure that the nut is perfectly tightened when refitting the upper spray arm.

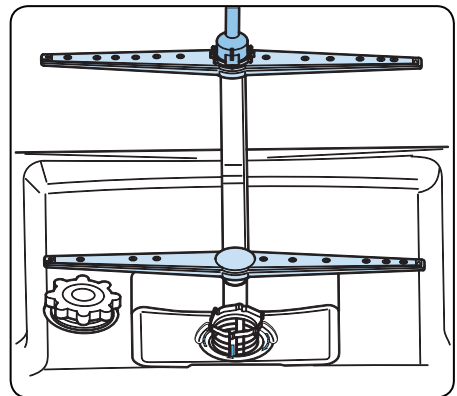



## 9.2. Cleaning The Impellers

Clean the impellers at least once a week in order for the machine operates efficiently.

### LOWER IMPELLER

Check if the holes on the lower impeller (1) are clogged. If they are clogged, remove and clean the impeller. Pull the lower impeller up to remove it (A, B.)

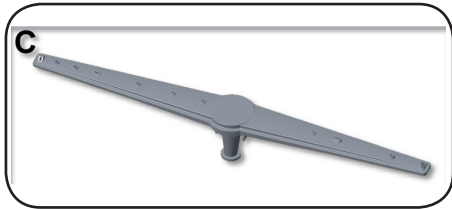
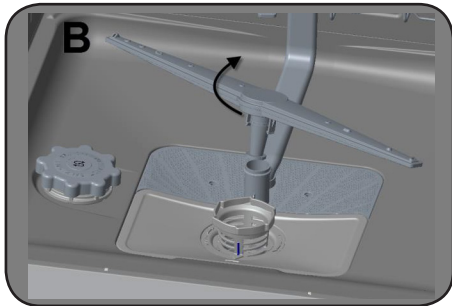
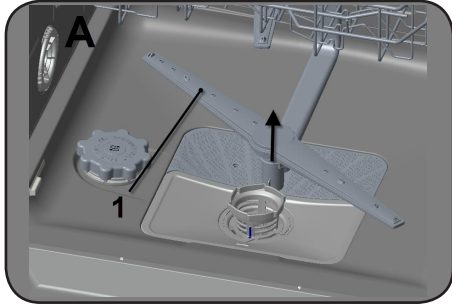

### UPPER IMPELLER

Check if the holes on the upper impeller

1 are clogged. If they are clogged, remove and clean the impeller. Turn its nut to left to re-move the upper impeller (A, B)

Make sure that the nut is tightened well when installing the upper impeller.

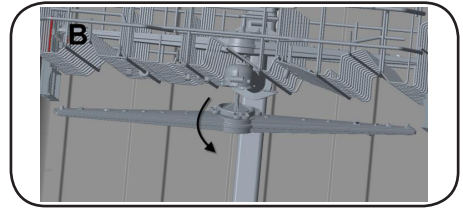
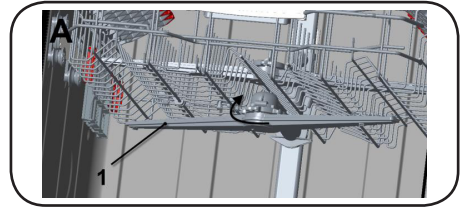

## WHAT SHOULD NOT BE WASHED IN YOUR DISHWASHER?

- All items to be placed in the dishwasher should be dishwasher safe.
- Plastics with “dishwasher safe” or equivalent label can only be used in dishwashers. Plastics may lose their shape or color. Check with manufacturer for recommendations.
- Any dishes made out of wood or made out with wooden parts are not suitable for washing in dishwashers. High temperatures can cause the wood swell or crack.
- Silver items without dishwasher safe label should not be washed in the dishwasher because high temperatures and detergent can damage your silver. Check with manufacturer for recommendations.
- Dishwasher safe silver items and stainless steel items should not come into contact, as the silver can become discolored.
- Porcelains and glassware with decorations and hand-painted utensils may lose their color and patterns due to the high temperatures. Non-decorated items are dishwasher-proof. Check with manufacturer for recommendations.
- Aluminum can turn dark in the dishwasher due to the heat, the detergent used or even just certain minerals in your water.
- Do not wash sponges or dish cloths in dishwasher.
- Do not wash any material like acrylic, copper, brass, pewter, iron, bronze or tin.
- Pots without a non-stick coating are safe to be cleaned by your dishwasher but some non-stick pots and pans can lose their coating and also sticking ability.
- Glued dishes or cutlery are not suitable for machine washing since adhesives that join materials such as plastic, wood, bone, steel, copper, tin, etc. may loosen.

Remember, if there is any doubt about any aspect concerning items to be washed in the dishwasher, follow the instructions from the manufacturer of the items, or wash the items by hand.

**⚠ WARNING:** If in doubt, wash by hand or follow the instructions from the manufacturer of utensils, dishes, glasses or pots and pans. Do not wash items soiled with cigarette ash, candle wax, varnish, paints or chemicals since they can damage your dishwasher.

**⚠ WARNING:** Empty the lower rack first and then the upper rack. This will avoid water dripping from the upper rack onto dishes in the lower rack.

**⚠ WARNING:** In general, it is not advisable to open the door while the dishwasher is in operation. If the door is opened, a safety device stops the dishwasher. Care should be taken when opening the door immediately following the cycle, as steam may escape.

## 10. TROUBLESHOOTING

FAULT	POSSIBLE CAUSE	TROUBLESHOOTING
The program does not start.	Your dishwasher is not plugged in.	Plug your dishwasher in.
	Your dishwasher is not switched on.	Switch your dishwasher on by pressing the On/Off key.
	Fuse blown.	Check your indoor fuses.
	Water inlet tap is closed.	Turn on the water inlet tap.
	Your dishwasher door is open.	Close the dishwasher door.
	Water inlet hose and machine filters are clogged.	Check the water inlet hose and machine filters and make sure they are not clogged.
Water remains inside the machine.	Water drain hose is clogged or twisted.	Check the drain hose, then either clean or untwist it.
	The filters are clogged.	Clean the filters.
	The program is not finished yet.	Wait until the program is finished.
Machine stops during washing.	Power failure.	Check mains power.
	Water inlet failure.	Check water tap.
Shaking and hitting noises are heard during a wash operation.	The spray arm is hitting the dishes in the lower basket.	Move or remove items blocking the spray arm.
Partial food wastes remain on the dishes.	Dishes placed incorrectly, sprayed water not reaching affected dishes.	Do not overload baskets.
	Dishes leaning each another.	Place dishes as instructed in the section on loading your dishwasher.
	Not enough detergent used.	Use the correct amount of detergent, as instructed in the program table.
	Wrong wash program selected.	Use the information in the program table to select the most appropriate program.
	Spray arms clogged with food waste.	Clean the holes in the spray arms with thin objects.
	Filters or water drain pump clogged or filter misplaced.	Check the drain hose and filters are correctly fitted.

## AUTOMATIC FAULT WARNINGS AND WHAT TO DO

TROUBLE CODE	POSSIBLE FAULT	WHAT TO DO
FF	Water inlet system failure	Make sure the water inlet tap is open and water is flowing.
		Separate the inlet hose from the tap and clean the filter of the hose.
		Contact for service if the error continues.
F5	Pressure system failure	Contact for service.
F3	Continuous water input	Close the tap and contact for service.
F2	Inability to discharge water	Water discharge hose and filters may be clogged.
		Cancel the program.
		If the error continues, contact for service.
F8	Heater error	Contact for service.
F1	Overflow	Unplug the machine and close the tap.
		Contact for service.
FE	Faulty electronic card	Contact for service.
F7	Overheating	Contact for service.
F9	Divisor position error	Contact for service.
F6	Faulty heater sensor	Contact for service.
HI	High voltage failure	Contact for service.

## 11. PRACTICAL INFORMATION

1. When the machine isn't in operation:

- Disconnect the plug and close the tap.
- Leave the door slightly open to prevent odour formation.

2. Select the dry option to remove water droplets.

3. Place dishes in the machine properly to achieve the best energy consumption, washing and drying performance. Please see the program and consumption table for more information.

4. Rinse dirty dishes before placing them in the dishwasher.

5. Only use the Rinse program when necessary.

6. Do not place the machine near a refrigerator because it will reach high temperatures.

7. If the machine is located in an area that is at risk of freezing, close the tap, disconnect the inlet hose from the tap and drain the water inside the hose and the machine completely, penses outside the metropolitan region.



**52314153 R35**

